





LET'S GRILL.

FEATURED

- 32" SIZZLER PRO GRILL
- 36" DOUBLE ACCESS DOOR
- 21" 4.5C DELUXE COMPACT REFRIGERATOR

(COVER PHOTO)

- 36" ALTURI
- ALTURI LIGHTED SEAR SIDE BURNER

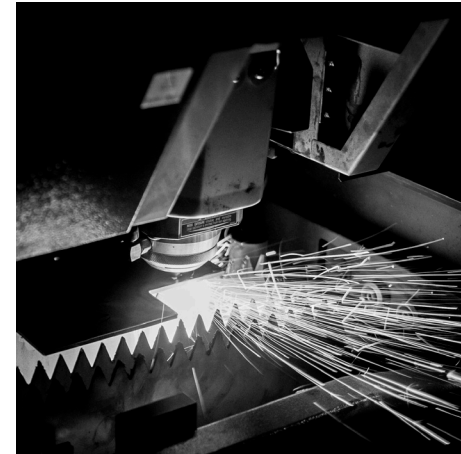

We are a family owned and operated business that is located in beautiful Huntington Beach, California. We pride ourselves in using only the best materials, and our commitment to quality is reflected in the craftsmanship of the entire Summerset line. With over 20 years of leadership in branding and manufacturing, our core focus is to provide exceptional customer service backed by AMD Direct's Gold Standard Lifetime Warranty.

Summerset Grills strives to meet every outdoor living expression. We offer a wide range of products from grills, refrigeration, sinks, storage solutions, and more. Our goal is to ensure you have everything you need to create your perfect outdoor atmosphere. No matter the style or budget, Summerset will deliver an experience that will help create the ultimate backyard getaway.

Table of Contents

Grills08
Outdoor Oven22
Side & Power Burners24
Freestanding Carts26
Cold Storage & Sinks32
Outdoor Kitchen Storage40
Grill & Island Accessories50
Warranty60
Contact Information.....64

FEATURED
- 36" ALTURI GRILL
- 24" 5.3C DELUXE OUTDOOR RATED DUAL ZONE WINE COOLER



Grills

Summerset Grills offers a complete line of commercial grade stainless steel barbecue grills. Whether you're looking for a simple, clean, entry-level grill like the Sizzler, or a entirely Made-in-America, luxury appliance like the Alturi, we have it all.



FEATURED

- 32" SIZZLER PRO GRILL
- 21" 4.5C DELUXE COMPACT REFRIGERATOR
- 36" DOUBLE ACCESS DOOR

BURNER TYPES

Bringing quality and performance together, our grill lines come equipped with either Stainless Steel Tube Burners, Stainless Steel U-Tube Burners, or Cast Stainless Burners.

LIGHTING FEATURES

Proper lighting creates drama, style, and function. LED Front Panel Lighting fetches eye-catching flair, while Interior Halogen Lighting provides needed illumination for grilling regardless of the time of day.

INNOVATIONS

Our grills facilitate outdoor living by providing functional and innovative feature sets, such as rotisserie spit holders, built-in drip trays to keep your area clean and safe, and double-lined hoods for durability and maximum heat retention.

STAINLESS STEEL CONSTRUCTION

Our grills are made to weather the elements allowing them to remain the centerpiece of your outdoor kitchen. All Summerset grills and accessories feature high-quality stainless steel, providing durability and are backed by the Gold Standard Lifetime Warranty.

VERSATILITY

Whether it is built-in or freestanding, size (sleek 26" up to spacious 42"), or total BTUs (from 36,000 to 119,000), our grills offer the versatility to maximize every outdoor space. Providing a variety of cooking methods (gas, rotisserie, and infrared) gives you the creative freedom you deserve.









FEATURED

- 32" SIZZLER PRO GRILL (TOP LEFT)
- 36" ALTURI GRILL (BOTTOM LEFT)
- 30" RESORT GRILL (TOP RIGHT)
- GAS TIMER WITH EMERGENCY SHUTOFF
- 27" HORIZONTAL ACCESS DOOR



ALTURI

The Alturi Series can be summed up in one word: luxury. Designed with elegance, made in the U.S., fueled with power, and loaded with every feature, this grill sets the bar for luxury outdoor cooking. Details like the angle-mounted interior lights, rotisserie storage, and spring-assisted hood provide ultimate convenience, while its #304 stainless steel construction and high BTU burners—the most durable on the market—guarantee lasting performance. When it comes to quality, style, and functionality, Alturi truly stands alone.

-  #304 Stainless Steel
-  Double-Lined Hood w/ Spring Assist
-  Heavy-Duty 9mm Cooking Grates
-  26,000 BTU Stainless Steel Tube Burners
-  15,000 BTU IR Back Burner
-  Interior and Exterior Lighting

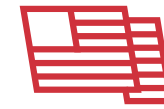
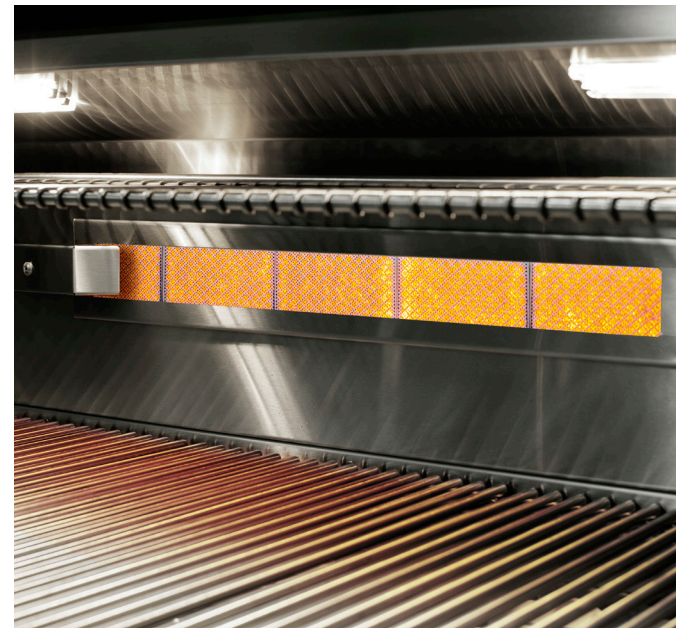

PROUDLY MADE
IN THE USA

ADDITIONAL FEATURES

- Interior Halogen Lighting
- Exterior LED Front Panel Lighting
- Heat Zone Separators
- Easy-Clean Briquette System
- Flame Thrower Ignition
- 40 lb. Motor with Rotisserie Kit Included
- 26,000 BTU Drop-In Sear Burner Available
- Matching Sear Side Burner, Double Side Burner, & Power Burner Available
- Red Brass Burners Available
- Grill Cover Included
- Built-In & Cart Models Available
- Teak Handle Available (ALT30-HTK, ALT36-HTK, ALT42-HTK)
- Built, Factory-Tested, & Serviced in the USA



30" ALTURI
ALT30T-NG / LP
 BTU'S: 67,000



36" ALTURI
ALT36T-NG / LP
 BTU'S: 93,000

*Shown with Optional
Wood Handle









42" ALTURI
ALT42T-NG / LP
 BTU'S: 93,000



TRL/TRLD

The TRL is a fully loaded workhorse, a grilling classic packed with luxury features. Complete with interior lights, exterior LEDs, rear infrared burner, rotisserie set, flame thrower valves, easy-clean briquette burner covers, and plug-and-play infrared sear zone options, the TRL makes professional grilling easy. With #304 stainless steel exterior construction and 16-gauge stainless steel burners backed by the Gold Standard Lifetime Warranty, this grill is built to last.

-  #304 Stainless Steel Exterior Construction
-  Double-Lined Hood
-  8mm Cooking Grates
-  18,000 BTU #304 Stainless Burners
-  15,000 BTU IR Back Burner
-  Interior and Exterior Lighting



ADDITIONAL FEATURES

- Interior Halogen Lighting
- Exterior LED Front Panel Lighting
- Heat Zone Separators
- Easy-Clean Briquette System
- Flame Thrower Ignition
- 40 lb. Motor with Rotisserie Kit Included
- 18,000 BTU Drop-In Sear Burner Available
- Matching Sear Side Burner, Double Side Burner, & Power Burner Available
- Built-In & Cart Models Available
- Cast Stainless Burners Available

TRLD ADDED FEATURES

- Cast Stainless Burners
- Heavy-Duty 9mm Cooking Grates



32" TRL
TRL32-NG / LP

 BTU'S: 69,000



38" TRL
TRL38-NG / LP

 BTU'S: 87,000









44" TRL DELUXE
TRLD44-NG / LP

 BTU'S: 87,000



SIZZLER PRO

The Sizzler Pro Series combines features, quality construction, and affordability. Based on the same sleek design of our classic Sizzler, with the addition of interior and exterior lighting, 14,000 BTU cast burners and heat zone separators, this grill really sets itself apart. The best part is... it won't break your wallet.

-  Commercial Grade Stainless Steel
-  Double-Lined Hood
-  8mm Cooking Grates
-  14,000 BTU Cast Stainless Burners
-  15,000 BTU IR Back Burner
-  Interior and Exterior Lighting

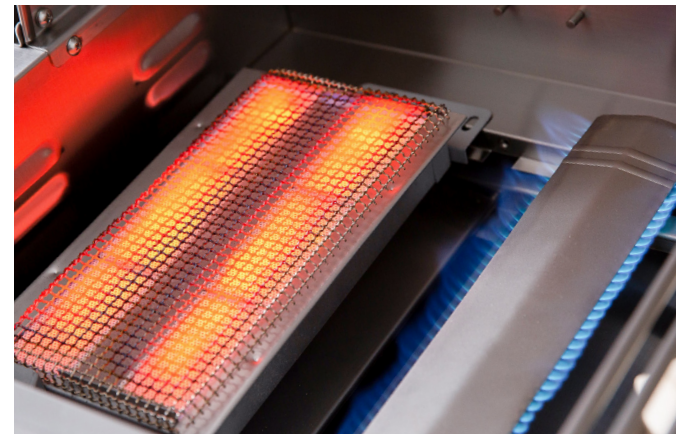

ADDITIONAL FEATURES

- Interior Halogen Lighting
- Exterior LED Front Panel Lighting
- Heat Zone Separators
- Easy-Clean Briquette System
- Flame Thrower Ignition
- Manual Flash Tube Ignition
- Rotisserie Kit Available
- Matching Double Side Burner Available
- Side Burner Cart Bracket Available
- Built-In & Cart Models Available
- 14,000 BTU Drop-In Sear Burner Available



32" SIZZLER PRO
SIZPRO32-NG / LP
 BTU'S: 71,000







40" SIZZLER PRO
SIZPRO40-NG / LP
 BTU'S: 87,000

*Shown with Optional Rotisserie Kit



SIZZLER

The Sizzler Series is a premium product at an unbeatable price. The streamlined version of the Sizzler Pro, it is constructed in all commercial grade stainless steel and designed with careful precision to ensure optimal airflow and even heating. This grill gives its higher-priced competitors a run for their money in both durability and grilling performance, impressing culinary experts and everyday chefs alike.

-  Commercial Grade Stainless Steel
-  Double-Lined Hood
-  8mm Cooking Grates
-  12,000 BTU Stainless Tube Burners
-  15,000 BTU IR Back Burner

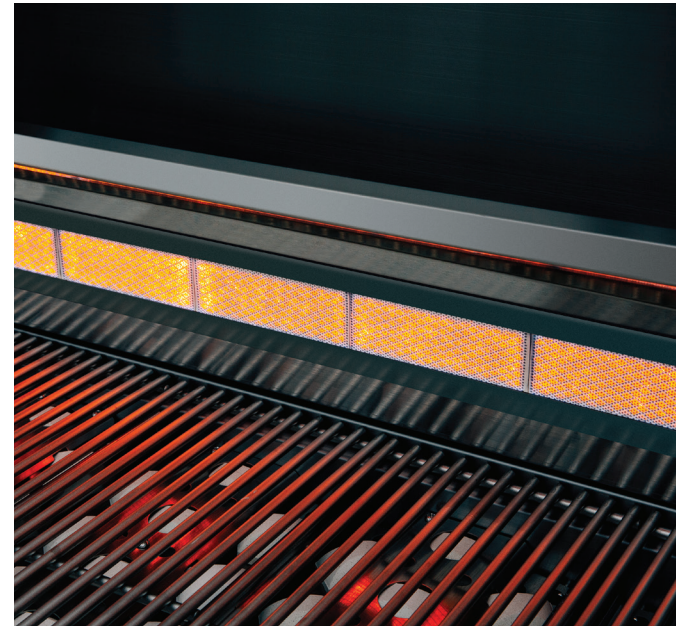
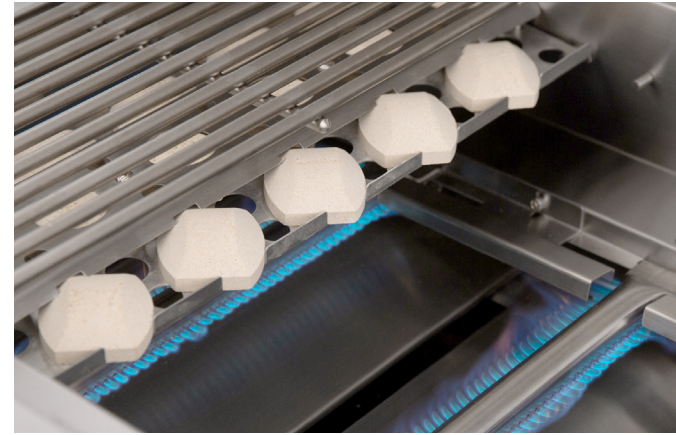

ADDITIONAL FEATURES

- Easy-Clean Briquette System
- Flame Thrower Ignition
- Manual Flash Tube Ignition
- Rotisserie Kit Available
- Matching Double Side Burner Available
- Side Burner Cart Bracket Available
- Built-In & Cart Models Available
- 12,000 BTU Drop-In Sear Burner Available
- Cast Stainless Burners Available



26" SIZZLER
SIZ26-NG / LP

 BTU'S: 36,000



32" SIZZLER
SIZ32-NG / LP

 BTU'S: 63,000



40" SIZZLER
SIZ40-NG / LP





 BTU'S: 75,000

*Shown with Optional Rotisserie Kit



RESORT GRILL

The Summerset Resort Grill has been specially designed to accommodate all types of multi-family and commercial applications. Whether it is an apartment community, hotel, or country club, these environments get a great deal of extra use. Donning the same beefed-up body as our luxury Alturi series, the Resort Grill is made with Commercial Grade stainless steel construction, 9mm cooking grates, and extra thick 14-gauge stainless steel flame tamers. Available in both built-in and pedestal models, this grill is the perfect option for any commercial application.

-  #304 Stainless Steel
-  Double-Lined Hood
-  Heavy-Duty 9mm Cooking Grates
-  26,000 BTU #304 Stainless Burners
-  Flame Thrower Ignition

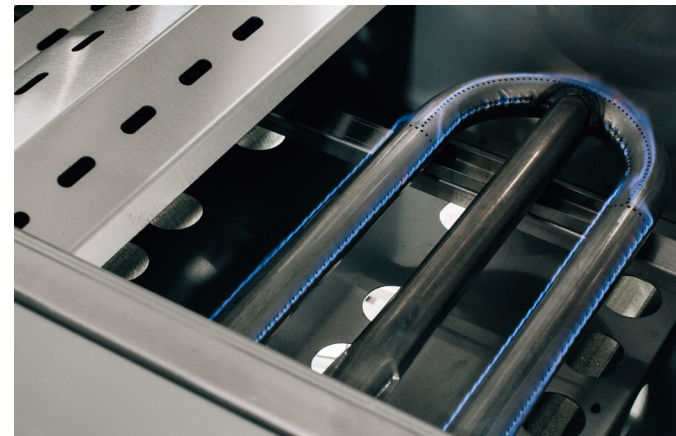

PROUDLY MADE
IN THE USA

ADDITIONAL FEATURES

- Heavy-Duty 14-Gauge Flame Tamers
- Locking Drip Tray
- Heavy-Duty Anti-Theft Knobs
- LP Conversion Kit Included
- Built-In and Pedestal Models Available
- Timer Panel Sold Separately
- Built, Factory Tested, and Serviced in the USA



30" RESORT GRILL
SBG30-NG / LP
 BTU'S: 52,000

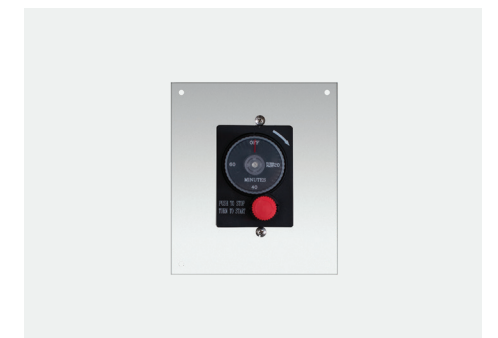

GAS TIMER WITH EMERGENCY SHUTOFF / MOUNTING PLATE
ESTOP1-0H / ESTOP2-5H
*Mounting Plate Sold Separately

Outdoor Oven

From appetizers to desserts, this oven will bake it all. Now you can add pizzas, roasts, brownies and more to your outdoor menu. To top it off, its #304 stainless steel construction is sure to outlast the competition.







- Main Burner 16,000 BTU
- Built-In Halogen Cooking Light
- 3 Cooking Racks
- Large Oven Capacity; Cook up to a 16-Inch Pizza
- Utensil Drawer
- Convenient Electronic Ignition
- Full View Front Window with Temperature Gauge
- Cool Touch, Heat Resistant Handle
- Includes Food Safe Pizza Stone
- Includes Wood Chip Smoker Box for Extra Flavor
- CSA Certified
- LP Tank Sold Separately
- Available in NG and LP
- Includes Deluxe Freestanding or Built-in Cover (GRILLCOV-OVBI / CARTCOV-OVFS)



OUTDOOR OVEN
SS-OVBI-NG / LP



OUTDOOR OVEN WITH CART
SS-OVFS-NG / LP

-  **#304 Stainless Steel**
-  **Double-Lined Hood**
-  **3 Cooking Racks**
-  **16,000 BTU Main Burner**
-  **Pizza Stone and Smoker Box Included**
-  **Optional Pizza Accessory Kit (SSTOAK-1)**



*Shown with Hidden Utensil Drawer



*Some Items from Optional Pizza Accessory Kit Shown

Side & Power Burners

Here we've combined the comfort of an indoor kitchen range with all the benefits of being outside. Specially designed for performance and function, a Summerset side burner is the perfect addition to your outdoor kitchen. Commonly used for finish cooking, sauces, or heating foods that require lower, more controlled temperatures than your grill, a side burner offers the convenience of range top cooking and grilling simultaneously. Find the perfect side burner for your outdoor kitchen with four professional lines to choose from: Sizzler, Sizzler Pro, TRL and Alturi. All Summerset side burners feature stainless steel construction, heavy stainless steel grates, and up to 65,000 BTUs of power—all packed in a sleek design and backed by AMD Direct's Gold Standard Lifetime Warranty.



FEATURED
- ALTURI POWER BURNER



ALTURI POWER BURNER
ALTPB2
• Total BTU's: 65,000
• Stainless Steel Burner
• Cooking Surface: 20" x 20"
• Front Panel LED Lighting
• Protective Lid included



ALTURI LIGHTED DOUBLE SIDE BURNER
ALTSB2
• Total BTUs: 35,000
• Solid Brass Burners
• Cooking Surface: 21½ x 11½
• Front Panel LED Lighting

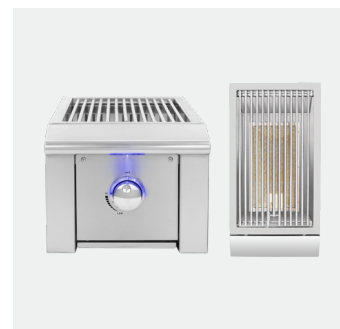

ALTURI LIGHTED SEAR SIDE BURNER
ALTSS
• Total BTUs: 26,000
• Infrared Burner (Up to 1600°F)
• Adjustable High/Low Technology
• Cooking Surface: 21¼ x 11½
• Front Panel LED Lighting

*Side Burners available in Natural Gas (NG) or Liquid Propane (LP)



TRL LIGHTED POWER BURNER
TRLPB2
• Total BTUs: 60,000
• Cooking Surface: 13½ x 17¼
• Cast Stainless Steel Dual Ring Burner
• Removable Center Grate for Wok Cooking
• Front Panel LED Lighting



TRL LIGHTED DOUBLE SIDE BURNER
TRLSB2
• Total BTUs: 30,000
• Cooking Surface: 19¼ x 11¼
• Front Panel LED Lighting



TRL SEAR SIDE BURNER
TRLSS
• Total BTUs: 15,000
• Cooking Surface 18-1/2" x 11-1/2"

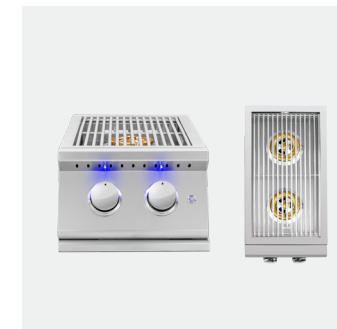

SIZZLER PRO LIGHTED DOUBLE SIDE BURNER
SIZPROSB2
• Total BTUs: 24,000
• Cooking Surface: 19½ x 10½
• Front Panel LED Lighting

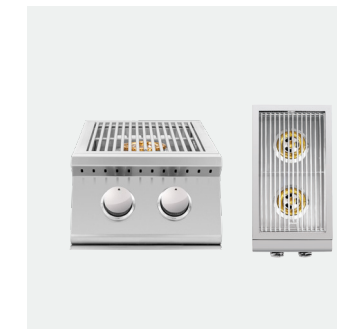

SIZZLER DOUBLE SIDE BURNER
SIZSB2
• Total BTUs: 24,000
• Cooking Surface: 19½ x 10½



SINGLE SIDE BURNER
SSSB1
• Total BTUs: 15,000
• Cooking Surface: 9½ x 9½



FEATURED
- SIZZLER PRO DOUBLE SIDE BURNER

Freestanding Carts

Summerset Professional Grills' complete line of grill carts offer a premium alternative to built-in models. Constructed of the highest quality stainless steel and manufactured in the USA, Summerset's durable carts offer stability, storage and convenience for casual and professional chefs alike.



FEATURED

- 38" TRL GRILL
- 38" TRL DELUXE CART

FREESTANDING CARTS



- SUMMERSET SIZZLER CART**
 CART-SIZ (SIZZLER 26, 32, 40)
- Commercial Grade Stainless Steel
 - Magnetic Double Access Door
 - Front Locking Caster Wheels
 - Interior Paper Towel Holder
 - Propane Tank Storage
 - Side, Rear and Bottom Ventilation
 - Made in America



- SUMMERSET SIZZLER DELUXE CART**
 CART-SIZDC (SIZZLER PRO DELUXE CART 32 & 40)
- Commercial Grade Stainless Steel
 - Magnetic Access Door with 2-Drawer Storage
 - Front Locking Caster Wheels
 - Interior Paper Towel Holder
 - Propane Tank Storage
 - Side, Rear and Bottom Ventilation
 - Fully Assembled
 - Made in America



- SUMMERSET TRL CART**
 CART-TRL (TRL 32 & 38)
- Commercial Grade Stainless Steel
 - Magnetic Double Access Door
 - Front Locking Caster Wheels
 - Interior Paper Towel Holder
 - Propane Tank Storage
 - Side, Rear and Bottom Ventilation
 - Made in America



- SUMMERSET TRL DELUXE CART**
 CART-TRLDC (TRL 32, 38, 44)
- Commercial Grade Stainless Steel
 - Magnetic Access Door with 2-Drawer Storage
 - Front Locking Caster Wheels
 - Interior Paper Towel Holder
 - Propane Tank Storage
 - Side, Rear and Bottom Ventilation
 - Fully Assembled
 - Made in America



FEATURED
 - SIZZLER DELUXE CART



PROUDLY MADE
 IN THE USA

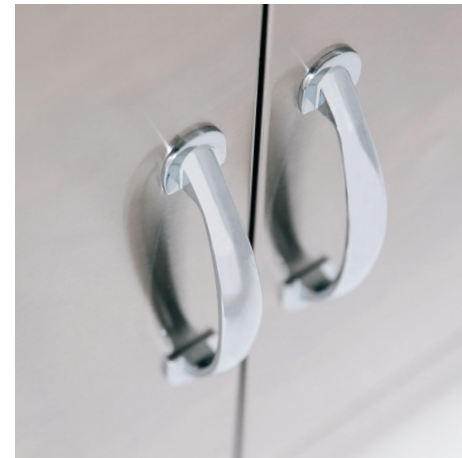



FEATURED - ALTURI 42" CART

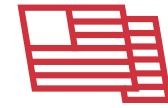

PROUDLY MADE
IN THE USA

FREESTANDING CARTS (CONT.)



SUMMERSET RESORT PEDESTAL

CART-PED

- Commercial Grade Stainless Steel
- Locking Double Door
- Propane Tank Storage
- Side, Rear and Bottom Ventilation
- Fully Assembled
- Also Available with Wheels (CART-ALT30)
- Timer Available
- Made in America



SUMMERSET RESORT CART

CART-ALT30

- Commercial Grade Stainless Steel
- Magnetic Double Door Access
- Locking Caster Wheels
- Interior Door Condiment Tray
- Propane Tank Storage
- Side, Rear and Bottom Ventilation
- Fully Assembled
- Made in America



SUMMERSET ALTURI 30" CART

CART-ALT30

- Commercial Grade Stainless Steel
- Magnetic Double Door Access
- Locking Caster Wheels
- Interior Door Condiment Tray
- Propane Tank Storage
- Side, Rear and Bottom Ventilation
- Fully Assembled
- Made in America



SUMMERSET ALTURI CART

CART-ALT (ALTURI 36 & 42)

- Commercial Grade Stainless Steel
- Magnetic Access Door with 2-Drawer Storage
- Locking Caster Wheels
- Interior Door Condiment Tray
- Propane Tank Storage
- Side, Rear and Bottom Ventilation
- 30" Model Features Double Access Doors
- Fully Assembled
- Made in America

Cold Storage & Sinks

Enjoy fresh ingredients and chilled beverages with our full line of cold storage products. All refrigeration offers durable construction for the outdoors, temperature control, adjustable legs for leveling, and sleek design for function and beauty. Bring the sophistication of your indoor refrigeration systems outside with matching performance and design.

FEATURED
- 30" LIGHTED BEVERAGE & PREP STATION
- 36" DOUBLE DOOR



21" REFRIGERATION SERIES

The 21" Compact Refrigerator Series offers 4.5 cubic feet of storage, reversible #304 stainless steel doors, and automatic interior lighting. Build them into an island or use them inside—these refrigerators will add a whole new level of convenience to your setup.



21" 4.5C COMPACT REFRIGERATOR
SSRFR-21S / SSRFR-21S-R
• Reversible Door Capability
• 32° - 50° Temperature Range



21" 4.5C DELUXE COMPACT REFRIGERATOR
SSRFR-21D / SSRFR-21D-R
• Left and Right Doors Available
• 32° - 50° Temperature Range

FEATURES:

- #304 Stainless Steel Door Construction
- Storage Capacity: 4.5 ft³
- Locking Doors
- Manual Temperature Controller
- Built-In Design
- Rear Venting
- Commercial & Residential Compliant

OUTDOOR REFRIGERATION

We offer a wide variety of luxury stainless steel refrigerators. From 3.2 to 6.6 cubic feet of storage, these appliances will help keep your food fresh, wine chilled, and beer cold, bringing the function of your indoor refrigeration outside to join the party.



24" 5.3C OUTDOOR RATED REFRIGERATOR
SSRFR-24S / SSRFR-24S-R
• Storage Capacity: 5.3 ft³
• 32° - 50° Temperature Range



24" 5.3C DELUXE OUTDOOR RATED REFRIGERATOR
SSRFR-24D / SSRFR-24D-R
• Storage Capacity: 5.3 ft³
• 32° - 50° Temperature Range

FEATURES:

- #304 Stainless Steel Door Construction
- UL Rated for Outdoor Use
- Locking Doors
- Front Venting
- Left and Right Doors Available
- Auto-Defrost
- Electronic Temperature Controller w/ Digital Display
- Built-In Design
- Commercial & Residential Compliant



FEATURED

- 21" COMPACT REFRIGERATOR (LEFT) - 24" OUTDOOR RATED REFRIGERATOR (RIGHT)



24" 5.3C DELUXE OUTDOOR RATED 2-DRAWER REFRIGERATOR
SSRFR-24DR2
• Storage Capacity: 5.3 ft³
• Two Soft-Close Drawers
• 32° - 50° Temperature Range



15" 3.2C OUTDOOR RATED REFRIGERATOR
SSRFR-15S
• Storage Capacity: 3.2 ft³
• 32° - 50° Temperature Range



15" 3.2C OUTDOOR RATED FRIDGE WITH GLASS DOOR
SSRFR-15G
• Storage Capacity: 3.2 ft³
• 32° - 50° Temperature Range

KEGERATORS



**24" 6.6C DELUXE OUTDOOR RATED KEGERATOR
(NO TAP / SINGLE TAP / DOUBLE TAP)**

SSRFR-24DK / SSRFR-24DK1 / SSRFR-24DK2

- Storage Capacity: 6.6 ft³
- Top Guard Rail Sold Separately
- Available in Single or Double Tap Towers
- 32° - 50° Temperature Range



SINGLE KEG TAP FOR KEGERATOR

SSRFR-TAP-1

- Fits SSRFR-24DK
- Includes Tap Tray, Single Hose, CO2 Kit (Tank & Regulator)



DOUBLE KEG TAP FOR KEGERATOR

SSRFR-TAP-2

- Fits SSRFR-24DK
- Includes Tap Tray, Two Hoses, CO2 Kit (Tank & Regulator)



ICE MAKERS



**50 LB. DELUXE OUTDOOR RATED ICE MAKER
W/ GRAVITY DRAIN**

SSIM-15

- Daily Ice Output: 50 lbs.
- Storage Capacity: 25 lbs.
- Gravity Drain
- Temperature Control Not Necessary

WINE COOLERS



**24" 5.3C DELUXE OUTDOOR RATED
WINE COOLER**

SSRFR-24W

- Storage Capacity: 5.3 ft³
- Tinted Glass
- 54 Bottle Capacity
- 41° - 64° Temperature Range



**24" 5.3C DELUXE OUTDOOR RATED
DUAL ZONE WINE COOLER**

SSRFR-24WD

- Storage Capacity: 5.3 ft³
- Tinted Glass
- 54 Bottle Capacity
- Upper Temperature Range: 41° - 50°
- Lower Temperature Range: 50° - 64°



**15" 3.2C OUTDOOR RATED SINGLE
ZONE WINE COOLER**

SSRFR-15W

- 28 Bottle Capacity
- Anti-Vibration System
- 41° - 64° Temperature Range



**15" 3.2C OUTDOOR RATED DUAL
ZONE WINE COOLER**

SSRFR-15WD

- 20 Bottle Capacity
- Anti-Vibration System
- Upper Temperature Range: 41° - 50°
- Lower Temperature Range: 50° - 64°

SINKS AND BAR PREP

Take your outdoor kitchen to the next level with our Beverage Center and selection of drop-in sinks. Complete with an ice compartment, sink, towel holder, speed rail with condiment tray, and built-in bottle opener, the Beverage Center will make you the best host in the neighborhood. Don't worry, when the sun goes down the LEDs will light it up and keep the party going!



15" DROP-IN SINK & HOT/COLD FAUCET
SSNK-15D

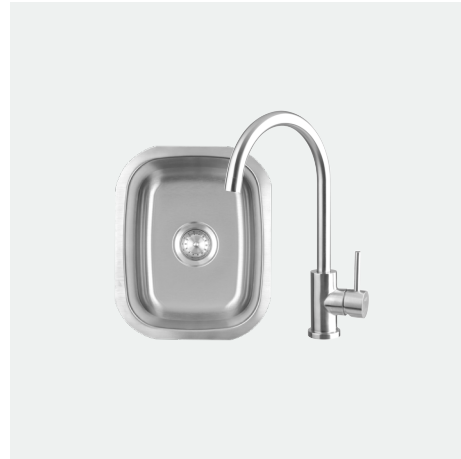

19" UNDERMOUNT SINK & 360° HOT/COLD FAUCET
SSNK-19U



FARMHOUSE SINK
SSNK-32F
*Faucet Sold Separately



30" LIGHTED BEVERAGE & PREP STATION
SSBC-30L



FEATURED
- 19" UNDERMOUNT SINK & FAUCET

ICE CHESTS

With our grills heating things up, we have just what you need to keep cool. Choose between two sizes to optimize your serving station. With up to 40 lbs. of ice capacity, load them up with refreshments, snacks, or ingredients to make for a good time.

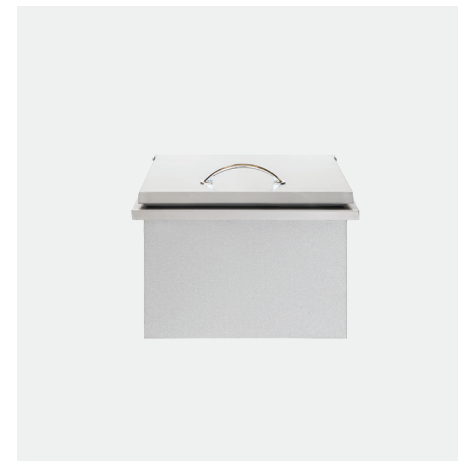

17" 1.7C DROP-IN COOLER (20LB ICE CAPACITY)
SSIC-17



28" 2.7C DROP-IN COOLER (40LB ICE CAPACITY)
SSIC-28

Outdoor Kitchen Storage

Our full line of outdoor kitchen storage features a heavy-duty flange and soft closing drawers. Double-lined construction provides the extra insulation and resilience needed against the elements, and a thicker flange provides a sturdy, seamless fit and elegant style that will work with any countertop and island finish. Soft closures bring the luxury of an indoor kitchen to the outdoor space. Our components also feature commercial grade stainless steel construction, magnetic latch, smooth gliding drawers on heavy-duty tracks, and a Gold Standard Lifetime Warranty. Plus, all access doors feature reversible door mounting to meet your specific needs. Sleek and intuitive, our components provide an integrated solution that can be personalized to any space.

FEATURED

- 17" DOUBLE DRAWER
- 36" DOUBLE ACCESS DOOR
- 24" 5.3C DELUXE OUTDOOR RATED 2-DRAWER REFRIGERATOR



ACCESS DOORS

Our access doors give you an elegant and convenient access to your island, utilities, and grill. Made with commercial grade stainless steel, heavy-duty flanges, reversible door mounting, and magnetic latches.

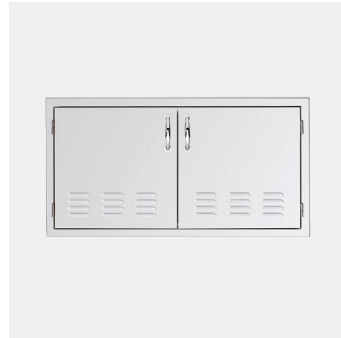

33" VENTED DOUBLE ACCESS DOOR

SSDD-33V

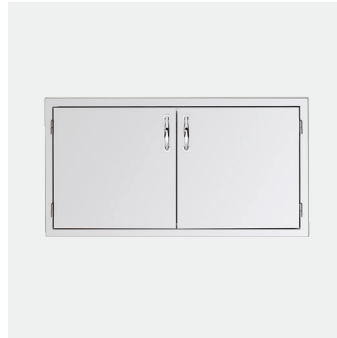

DOUBLE ACCESS DOOR (26", 30", 33", 36", 39", 42", 45")

SSDD-26 / SSDD-30 / SSDD-33
SSDD-36 / SSDD-39 / SSDD-42
SSDD-45



VERTICAL ACCESS DOOR (16", 18", 20")

SSDV-16 / SSDV-18 / SSDV-20



HORIZONTAL ACCESS DOOR (18", 22", 27")

SSDH-18 / SSDH-22 / SSDH-27

DOOR/DRAWER COMBOS

These components are specifically designed with versatility in mind. Whether you need a simple storage setup, LP tank drawer, paper towel holder, or weather-resistant dry storage shelving, these commercial grade stainless steel combos give you the options you need for a perfect outdoor setup.



2-DRAWER & ACCESS DOOR COMBO (30, 33, 36, 42")

SSDC2-30 / SSDC2-33
SSDC2-36 / SSDC2-42



33" 3-DRAWER & ACCESS DOOR COMBO

SSDC3-33



33" 2-DRAWER & LP TANK PULLOUT DRAWER COMBO

SSDC2-33LP



17" VERTICAL 2-DRAWER & PAPER TOWEL HOLDER COMBO

SSTDC-17



FEATURED

- 33" 3-DRAWER & ACCESS DOOR COMBO



STORAGE DRAWERS

Our line of drawers are feature-packed storage options that ensure you get exactly what you need in your backyard set up. Made with commercial grade stainless steel, these drawers feature heavy-duty flanges and soft closing drawers.

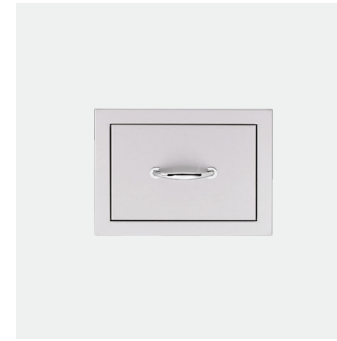

17" SINGLE DRAWER
SSDR1-17



17" DOUBLE DRAWER
SSDR2-17



17" TRIPLE DRAWER
SSDR3-17



**20" VENTED LIQUID PROPANE
TANK OR TRASH DRAWER**
SSDR1-20LP



20" TRASH PULLOUT DRAWER
SSTD1-20



**20" TRASH & RECYCLING
2-BIN PULLOUT DRAWER**
SSTD2-20



17" PAPER TOWEL HOLDER
SSTH-17



26" UTENSIL DRAWER
SSDR1-26U

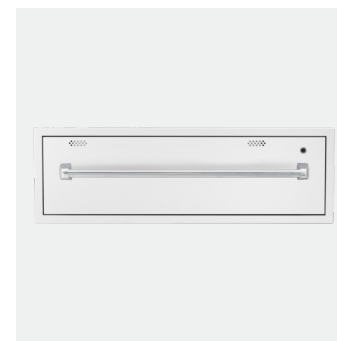

36" WARMING DRAWER
SSWD-36



**32" DOUBLE HORIZONTAL
DRAWER**
SSDR2-32H

FEATURED
- 20" TRASH PULLOUT DRAWER

DRY STORAGE

This line of dry storage pantries is a solution that offers heavy-duty weather-resistant seals to give you peace of mind year-round—that means moisture and critters are locked out for good. Made with only the highest quality commercial grade stainless steel, these pantries feature heavy-duty flanges and magnetic latches.



36" 2-DRAWER DRY STORAGE PANTRY & ENCLOSED CABINET COMBO

SSDP-36DC



36" 2-DRAWER DRY STORAGE PANTRY & ACCESS DOOR COMBO

SSDP-36AC



FEATURED

- 36" 2-DRAWER DRY STORAGE PANTRY & ENCLOSED CABINET COMBO
- 36" ALTURI GRILL
- 24" 6.6C DELUXE OUTDOOR RATED KEGERATOR



FEATURED - 33" MASONRY DOUBLE ACCESS DOOR

MASONRY STORAGE

Our line of Masonry Storage is perfect for islands with stone or brick finishes. The increased flange depth makes for a seamless fit and streamlined installation. These commercial grade stainless steel components can also be used to add an attractive contrast to any island with stucco or Ameristone finishes.



20" MASONRY VERTICAL ACCESS DOOR
SSDV-20M



27" MASONRY HORIZONTAL ACCESS DOOR
SSDH-27M



MASONRY DOUBLE ACCESS DOOR (33, 45")
SSDD-33M / SSDD-45M



20" MASONRY TRASH & LP TANK PULLOUT DRAWER
SSTD1-20M



33" MASONRY 2-DRAWER & ACCESS DOOR COMBO
SSDC2-33M

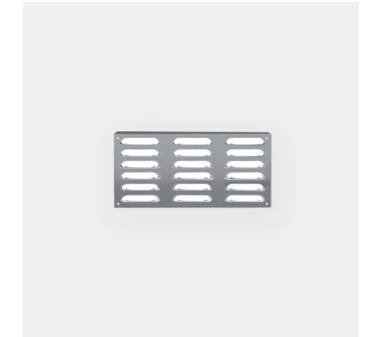

12" MASONRY ISLAND VENT PANEL
SSIV-12M



17" MASONRY DOUBLE DRAWER
SSDR2-17M



17" MASONRY VERTICAL 2-DRAWER & PAPER TOWEL HOLDER COMBO
SSTDC-17M

Grill & Island Accessories

Make your kitchen the way you want it... Summerset offers a variety of miscellaneous conveniences, upgrades, and appliances to customize your outdoor space to your liking. All products feature high-grade #304 stainless steel construction for durability and performance.

FEATURED

- SIZZLER PRO ROTISSERIE KIT
- 32" SIZZLER PRO GRILL
- 21" 4.5C DELUXE COMPACT REFRIGERATOR
- 30" DOUBLE ACCESS DOOR



SEAR BURNERS

Become the chef you've dreamed of by using Summerset Sear Burners. Our sear burners can replace nearly any burner position, giving you a customizable cooking experience and allowing you to burn and turn the way you want.

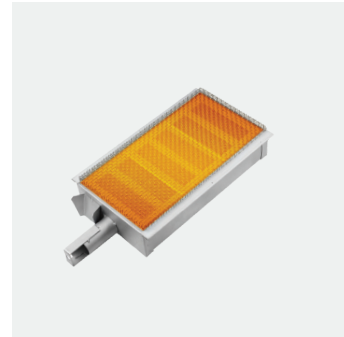

ALTURI DROP-IN INFRARED SEAR BURNER

IRB-ALT
BTU: 26,000

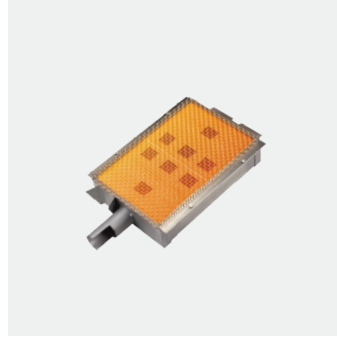

TRL/TRLD DROP-IN INFRARED SEAR BURNER

IRB-TRL
BTU: 18,000



SIZZLER DROP-IN INFRARED SEAR BURNER

IRB-SIZ
BTU: 12,000



SIZZLER PRO DROP-IN INFRARED SEAR BURNER

IRB-SIZ
BTU: 14,000

GRILL & SIDE BURNER LINERS

Summerset Grill Liners are designed with #304 stainless steel construction to protect any outdoor kitchen made of combustible material. The fitted Grill Liners provide an inch of double-walled insulation that blocks the heat from reaching combustible surfaces or framing such as wood or plastic, giving you the freedom to create your outdoor kitchen in the material of your choice.



GRILL LINER

GL-ALT30 / GL-ALT36 / GL-ALT42 / GL-TRL32 / GL-TRL38 / GL-TRLD44 / GL-SIZ26 / GL-SIZ32 / GL-SIZ40 / GL-SBG30



SIDE BURNER LINER

GL-SIZSB2 / GL-TRLSB2 / GL-TRLPB2 / GL-ALTSB/ALTSS / GL-APB2

ISLAND ACCESSORIES

For a sleek and well finished outdoor kitchen, count on us to pay attention to even the smallest of details. Trim your refrigerator cutout, seal your umbrella hole and ventilate in style with Summerset's stainless steel accessories. Finishing touches make luxury islands!



REFRIGERATOR TRIM 15"/21"/24" SERIES

SSRTK-15 / SSRTK-21 / SSRTK-24 / SSRTK-24W



14" ISLAND VENT PANEL

SSIV-14

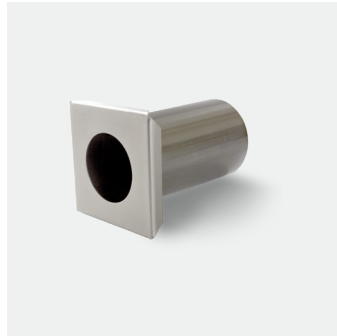

1.75" / 2" UMBRELLA COUNTERTOP MOUNTING STANCHION

SSUS-1 / SSUS-1L



12X6" ISLAND VENT PANEL W/ MASONRY FRAME RETURN

SSIV-12M

GRIDDLES

Breakfast, burgers, veggies, stir-fry—you name it! Whatever the occasion the ALL-NEW griddles are perfect for upgrading your grilling options! Built in the USA with #304 stainless steel, the Summerset griddle plate gives you 212 sq. in. of grilling space!



18" GRIDDLE PLATE

SSGP-18

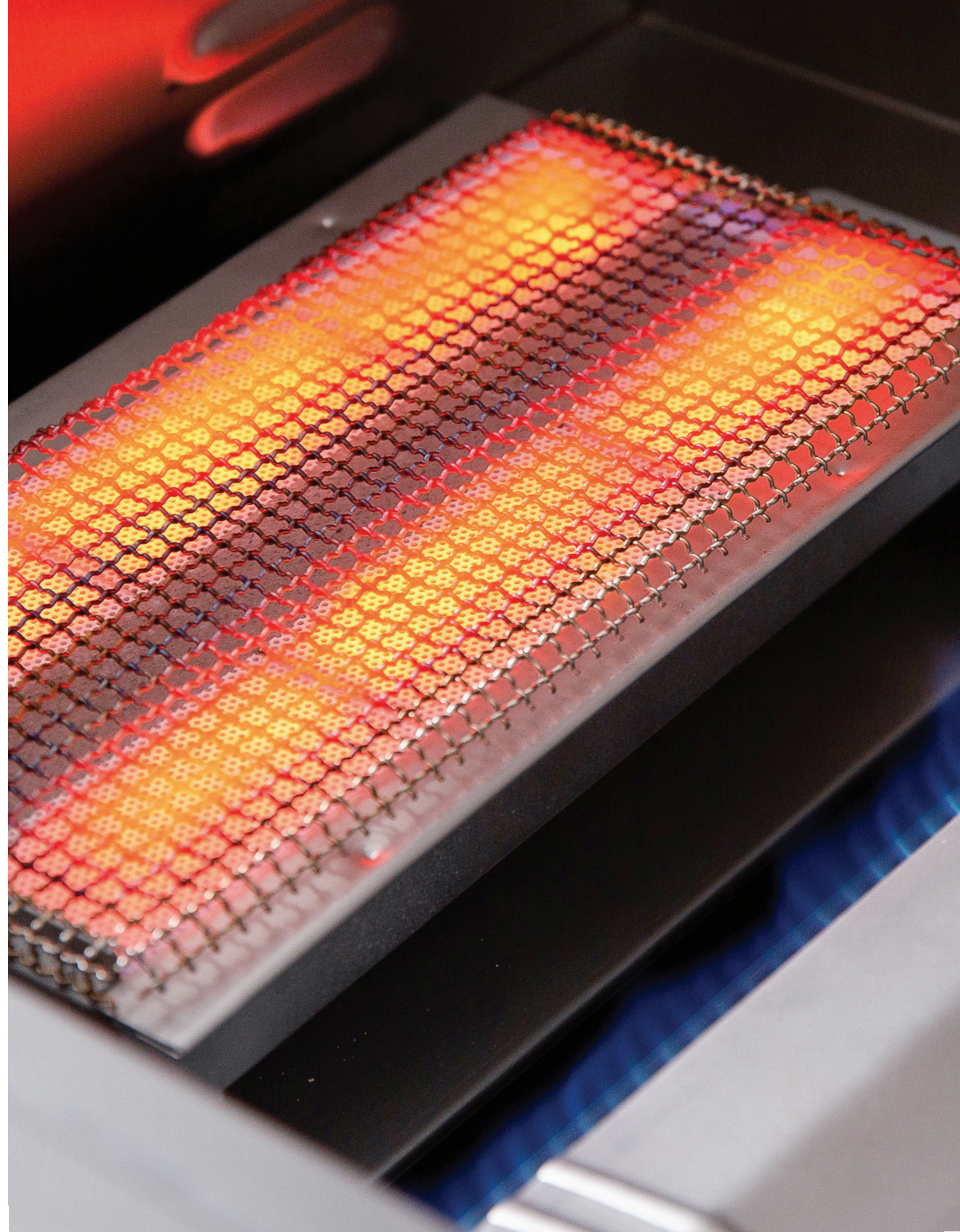



ROTISSERIE KITS AND BAGS

Complete with weather-protected stainless steel motor, fork set, counterbalance and a spit rod for every grill model, the Summerset rotisserie kits have everything you need to start cooking your chicken, turkey, loin or roast like a pro.



SUMMERSET ROTISSERIE KITS
 ROTKIT-SIZ26 / ROTKIT-SIZ32 /
 ROTKIT-SIZ40



ROTISSERIE KIT STORAGE BAG
 GRILLCOV-ROT32 / GRILLCOV-ROT44
 *Rotisserie Kit Sold Separately

APPLIANCE COVERS

Protect your outdoor kitchen appliances with Summerset Grills Covers. Our heavy-duty PVC covers are 100 percent water-resistant, UV-protected to prevent fading, custom fitted, and feature soft flannel backing (to keep your steel scratch-free). Covers available for Grills, Side Burners, & Ovens.



GRILL COVER
 GRILLCOV(-ALT30D, -ALT36D,
 -ALT42D, -26D, -32D, -38/40D, -44D)



CART COVER
 CARTCOV(-ALT30D, -ALT36D,
 -ALT42D, -26D, -32D, -38/40D, -44D)



SIDE BURNER COVER
 GRILLCOV(-SIZSB2, -SB1, -SB2, -PB,
 -ALTSB2, -APB2)



BUILT-IN OVEN COVER
 GRILLCOV-OVBI



FREESTANDING OVEN COVER
 GRILLCOV-OVFS



SIZZLER/ SIZZLER PRO SIDE BURNER BRACKET

Exclusively, the Sizzler models now have even more surface for grilling with the Side Burner Bracket. This unique design allows you to replace the right-hand side shelf with a housing bracket to simply mount a double side burner right next to your grill.



SIDE BURNER BRACKET
CART-SIZ-SB2BK

ALTURI WOOD HANDLE

Harness the rustic elements of the great outdoors with this new handle for the Alturi grill series. Fusing sleek stainless steel with a natural wooden elegance, the Summerset Teak wood handle for the Alturi grill is a fine finishing touch to your outdoor kitchen.



ALTURI WOOD HANDLE (TEAK)
(30", 36", 42")
ALT-HTK

GAS TIMER / MOUNTING PLATE

Bring utility and safety to your gas grill with the Summerset Gas Timer. Built with matching durable #304 stainless steel to weather the elements, this timer features a simple and sleek design, 1 hour and 2.5 hour settings.

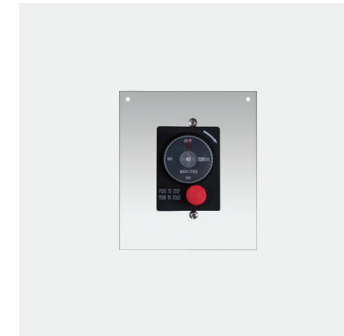

GAS TIMER WITH EMERGENCY SHUTOFF / MOUNTING PLATE
ESTOP1-0H / ESTOP2-5H
*Mounting Plate Sold Separately

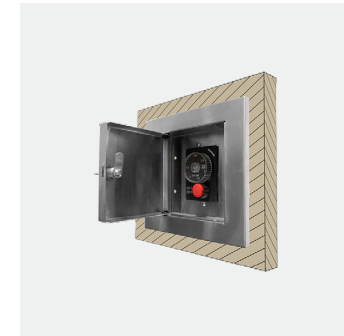

GAS TIMER LOCKING CABINET
ESTOP-LC-KIT / ESTOP-RM-KIT

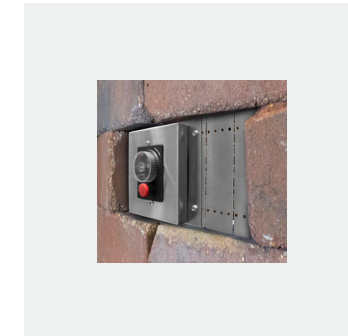

EXPANDABLE MASONRY GAS TIMER KIT
ESTOP-CP-KIT



VENT HOODS



VENT HOODS (36", 48", 60")
SSVH-36 / SSVH-48 / SSVH-60

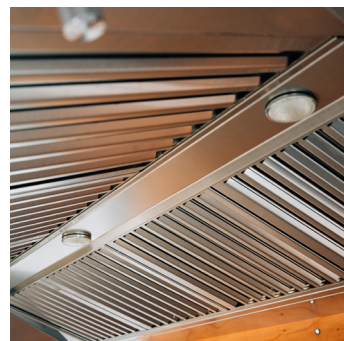

SPACER TEMPLATE
SSVH-36-SPT / SSVH-48-SPT / SSVH-60-SPT



SPACER BRACKETS (4", 8")
SSVH-36-SP4 / SSVH-48-SP4 / SSVH-60-SP4 / SSVH-36-SP8 / SSVH-48-SP8 / SSVH-60-SP8

WIND GUARDS



36" STAINLESS STEEL WIND GUARD (FITS 30-32" GRILLS)
SSWG-36



48" STAINLESS STEEL WIND GUARD (FITS 36-44" GRILLS)
SSWG-48

CUTTING BOARD & TRASH CHUTE

Add convenience to your outdoor kitchen with the Summerset Grills Cutting Board & Trash Chute. Add the Trash Chute above Summerset's Trash Drawer for easy cleanup. Made from #304 Stainless Steel, Summerset's Trash Chute is durable even in the harshest weather.



14" TRASH CHUTE & CUTTING BOARD WITH LID
SSTC-14

SMOKER TRAYS

Add some pizzazz to an otherwise ordinary meal with the Summerset Smoker Tray. Whether it's mesquite chicken or applewood smoked salmon, the smoker tray is the ultimate meal enhancer that allows for endless flavor options.



SMOKER TRAYS
SSMK-SIZ / SSMK-TRL

OVEN ACCESSORIES

Here are all the included tools that you will need for a successful night of pizza making. Be sure you use that glove, because this pizza will be coming out of the oven hot!



PIZZA STONE KIT
SSTOAK-1



FLANGE KIT
OV-FLANGE KIT



Cutouts

For cutouts, dimensions or more information on your Summerset product, visit [Summersetgrills.com/cutouts](https://summersetgrills.com/cutouts) or scan this QR Code with your smartphone's camera app.

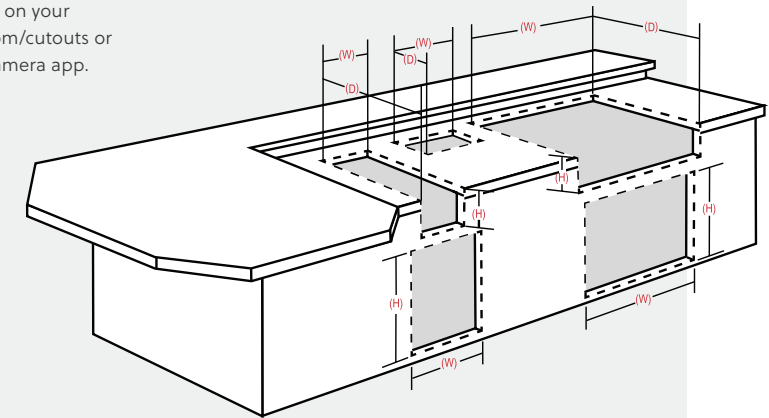



GOLD STANDARD WARRANTY

Your investment in AMD Direct product is backed by the strongest warranty in the industry. In addition to precision engineering and outstanding performance, AMD Direct products include our GOLD STANDARD LIFETIME WARRANTY with all replacement parts 100% non-prorated. Effective with purchases 8/1/21.

AMD Direct Warranty is valid for original purchaser at original site of delivery with proof of purchase and photo documentation only. Registration form must be submitted online within 30 days of the purchase date to validate the warranty. Warranty is void upon transfer of ownership. Warranty does not apply to products installed in any commercial, rental, or nonresidential application (exception of the Resort Grill, Alturi, & TRL). Warranty covers replacement parts only. Manufacturer is not responsible for labor or labor-related costs. Warranty does not cover discoloration, surface rust, corrosion, or oxidation, which may occur due to harsh environments, chemicals, or overheating. Warranty will not apply for damage resulting from improper installations, abuse, extreme environments, grease fires, or misuse. Proof of regular and proper maintenance is required. Coastal, humid, and/or salt environments are subject to manufacturer review. All out-of-box claims must be made within 30 days of purchase and must be made prior to installation. Any product installed damaged will be considered damaged during installation and not covered under warranty. Warranty and registration forms are available at www.amddirect.com/register. Please be advised - all display models are sold "as is" and the warranty covers the following items only: main burners (Gold Standard Lifetime Warranty), grates (Gold Standard Lifetime Warranty), burner covers (Gold Standard Lifetime Warranty). All warranties are subject to the review and approval of the manufacturer.

14520 DELTA LANE SUITE 105,
HUNTINGTON BEACH, CA 92647

800.966.8126

AMDDIRECT.COM

AMD DIRECT GAS APPLIANCES (GRILLS, SIDE/POWER BURNERS, & OVEN)

- Gold Standard Lifetime Warranty on construction and manufacturer defects
- Gold Standard Lifetime Warranty on stainless steel construction
- Gold Standard Lifetime Warranty on cooking grates, burners, burner covers, valves, flame tamers, and heatzone separators, temperature gauges, & hood springs
- Gold Standard Lifetime Warranty on briquette systems
- 3 YEAR Warranty on all other parts, components, & electrical, including: LED bulbs, wire harness, & switches; power source wire; transformer; interior halogen light wire & bulb

VENT HOODS, REFRIGERATION, COLD STORAGE & SINKS

VENT HOODS

- 5 Year Warranty on all Stainless Steel Construction
- 3 year Warranty on blowers, LED Lighting, wiring harness and switches

15" & 24" REFRIGERATION MODELS

- 3 year Warranty on all construction including compressors
- 1 year Warranty on transformer, LED bulbs, LED harness, power source wire, LED switches, interior halogen light wire/bulbs

21" REFRIGERATION MODELS

- 1 year Warranty on all construction & electrical components including compressor, transformer, LED bulbs, LED harness, power source wire, LED switches, interior halogen light wire/bulbs

COLD STORAGE & SINKS

- Gold Standard Lifetime Warranty on Ice Chests
- Gold Standard Lifetime Warranty on drains & faucets

DRAWERS, DOORS, GRILL LINERS, & CARTS

- Gold Standard Lifetime Warranty on construction, workmanship and materials for all stainless steel parts, including doors, drawers, grill liners, & carts
- 3 year on electrical (Warming Drawers)

COVERS

- Gold Standard Lifetime Warranty on covers, including grills, carts, side/power burners & oven

MADERA PRODUCTS

- Gold Standard Lifetime Warranty on construction, workmanship and materials for all stainless steel parts, hinges, drawer slides, gasket, & magnets

COMMERCIAL APPLICATIONS

RESORT, ALTURI & TRL GRILLS

- Gold Standard Lifetime Warranty on workmanship, construction, & manufacturer defects for all commercial and/or hospitality applications
- Warranty is void upon misuse, including lack of regular cleaning, vandalism, or theft
- Warranty is valid only if regular maintenance is exercised. Due to the nature of commercial applications (multiple users, lack of control of use, etc.) regular maintenance is mandatory



FEATURED

- 42" ALTURI GRILL
- TWO 24" 5.3C DELUXE OUTDOOR RATED REFRIGERATORS
- ALTURI LIGHTED SEAR SIDE BURNER



SUMMERSET

14520 Delta Ln
Suite 105
Huntington Beach,
CA 92647

(800) 966-8126

SUMMERSETGRILLS.COM